

version .0

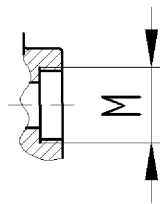
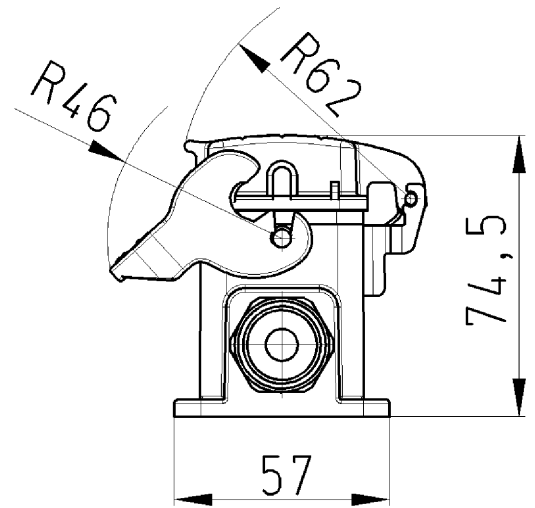
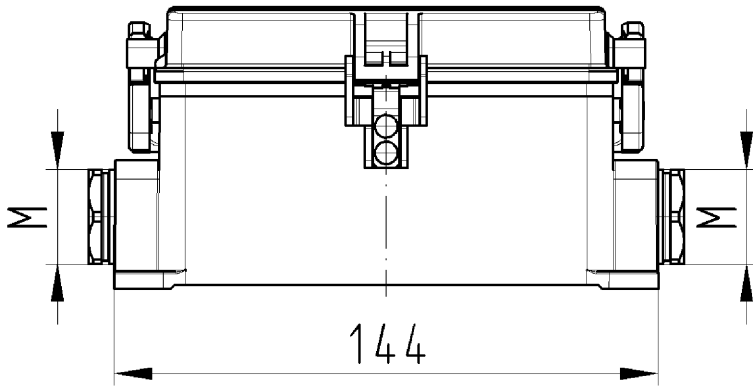

version .1

Gehäuseunterteil  
71.340.2435.0

Zeichnungsnummer  
71.340.2435.010W  
Gehäuseunterteil

11.12.2007  
Hoffmann Angelika  
M 1:2